

REVISIONS A (10/02/06)

DRAWN SA CHECKED DATE 14.02. 6 15:19

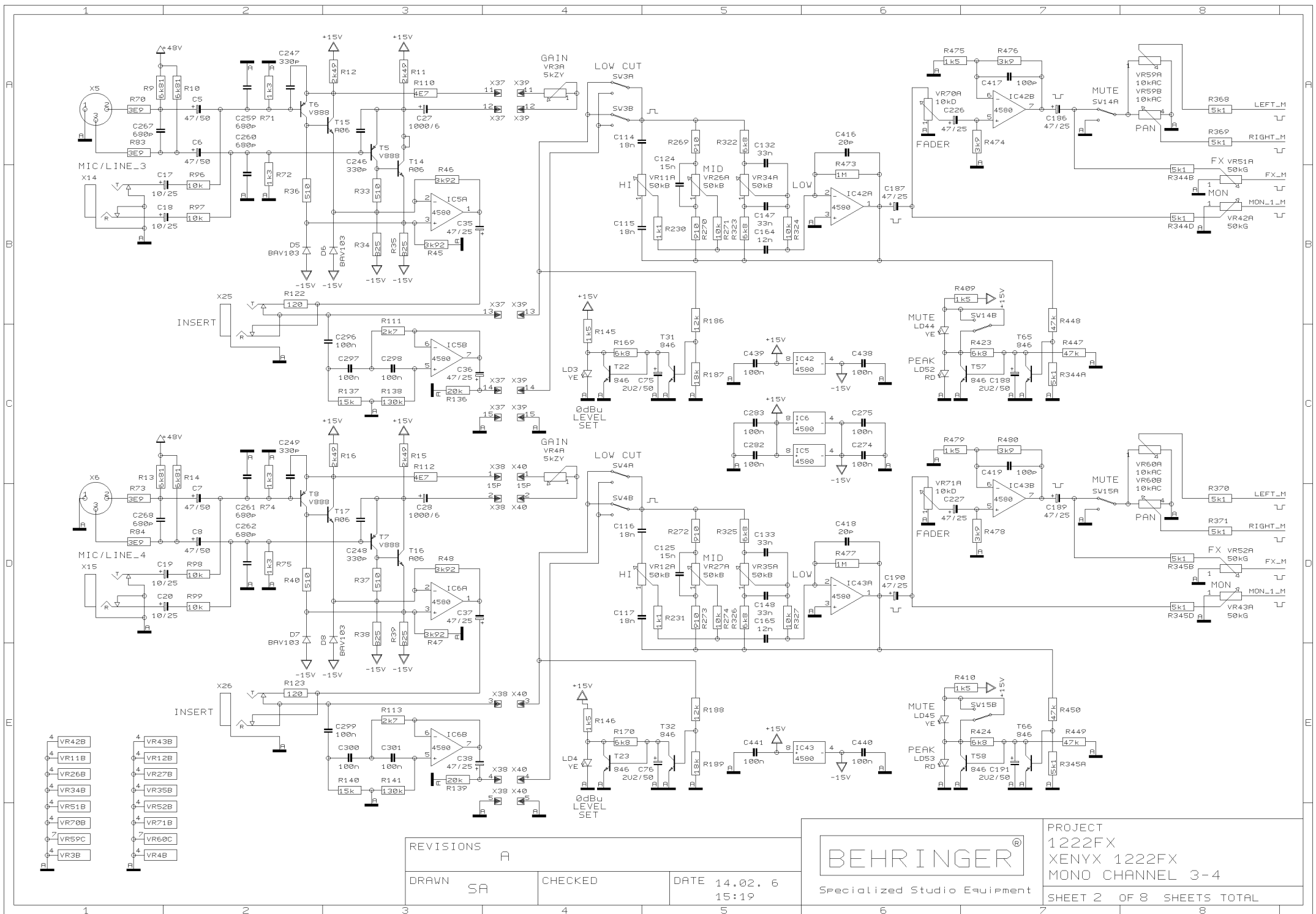

PROJECT 1222FX
 XENYX 1222FX
 MONO CHANNEL 1-2
 SHEET 1 OF 8 SHEETS TOTAL



REVISIONS

A

DRAWN SA

CHECKED

DATE 14.02. 6

15:19



Specialized Studio Equipment

PROJECT
1222FX
XENYX 1222FX
MONO CHANNEL 3-4
SHEET 2 OF 8 SHEETS TOTAL

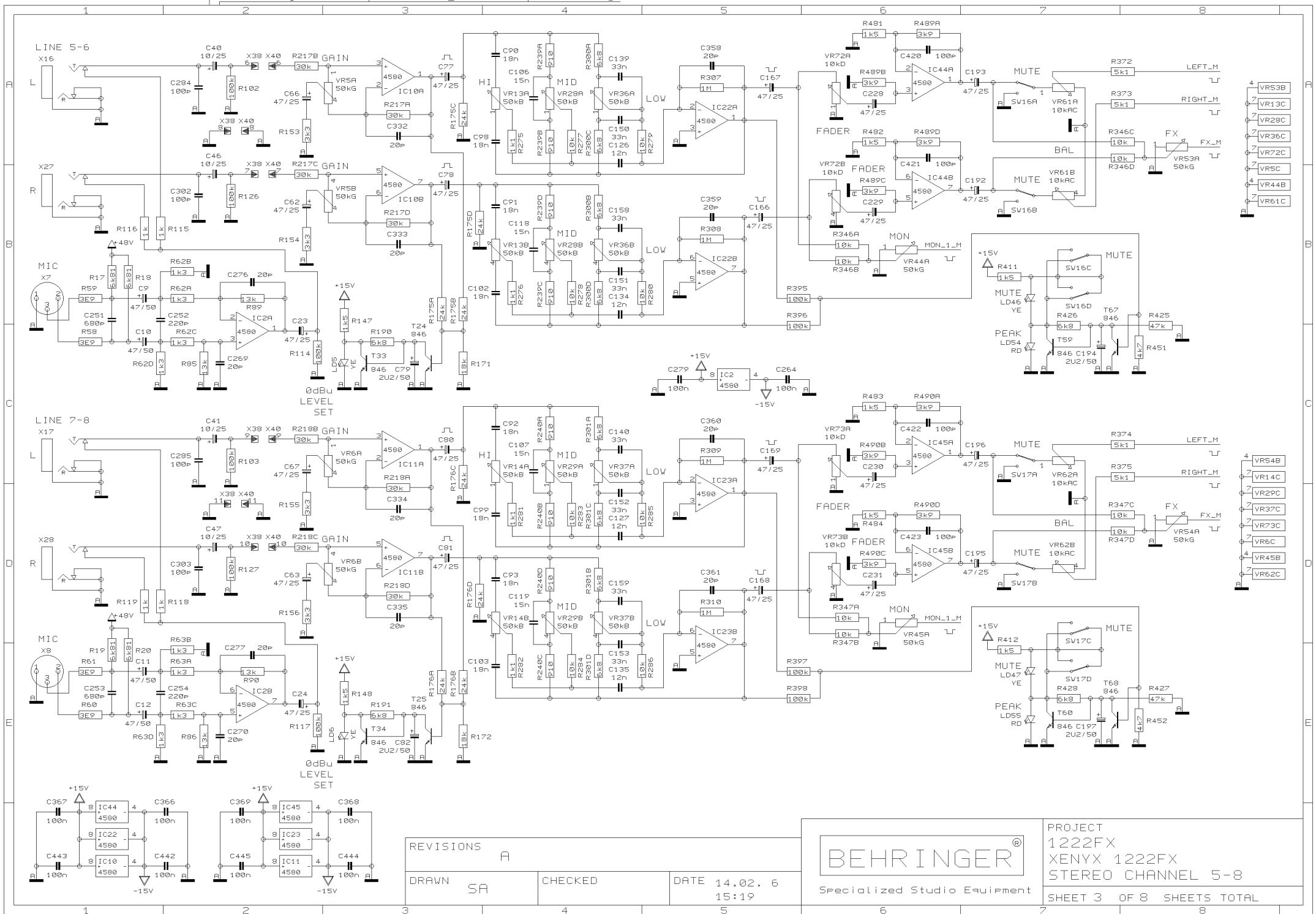

REVISIONS	A
DRAWN	SA
CHECKED	
DATE	14.02. 6 15:19



PROJECT
1222FX
XENYX 1222FX
STEREO CHANNEL 5-8
SHEET 3 OF 8 SHEETS TOTAL

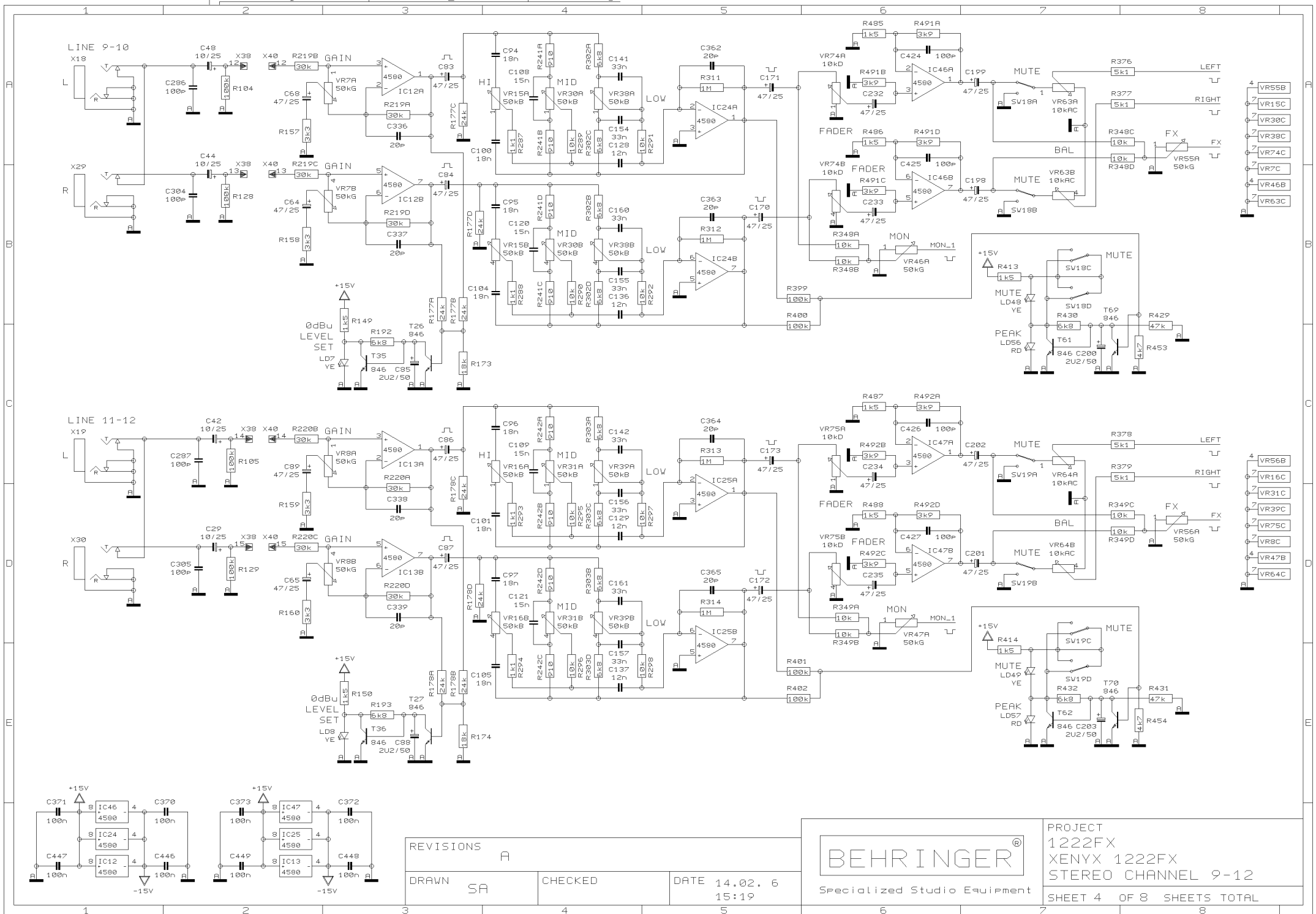

REVISIONS
A

DRAWN SA

CHECKED

DATE 14.02. 6
15:19



PROJECT
1222FX
XENYX 1222FX
STEREO CHANNEL 9-12
SHEET 4 OF 8 SHEETS TOTAL

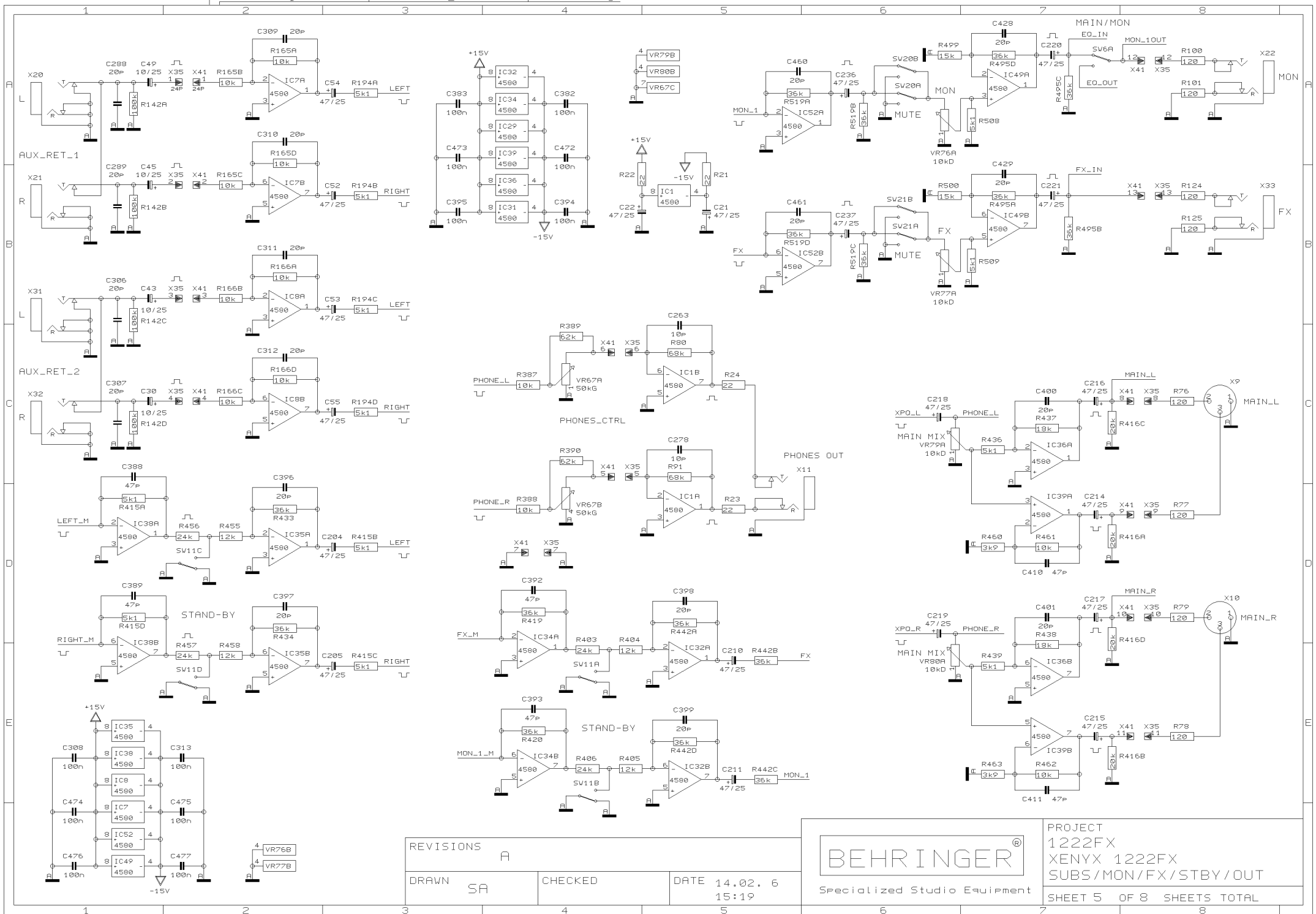

REVISIONS		A	
DRAWN	SA	CHECKED	
DATE		14.02. 6	
		15:19	



PROJECT
1222FX
XENYX 1222FX
SUBS/MON/FX/STBY/OUT
SHEET 5 OF 8 SHEETS TOTAL

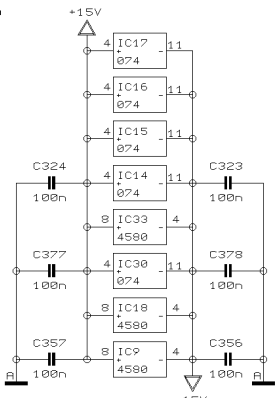
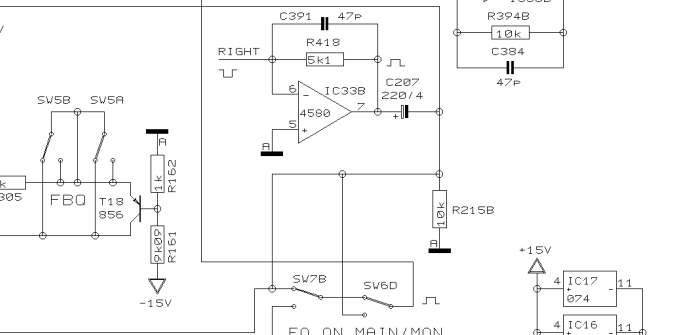
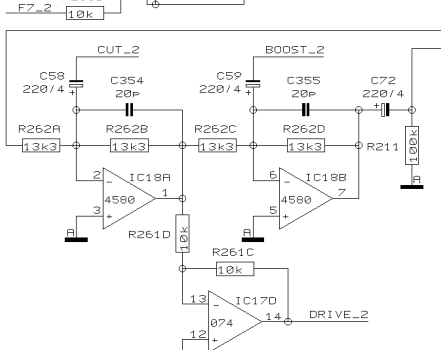
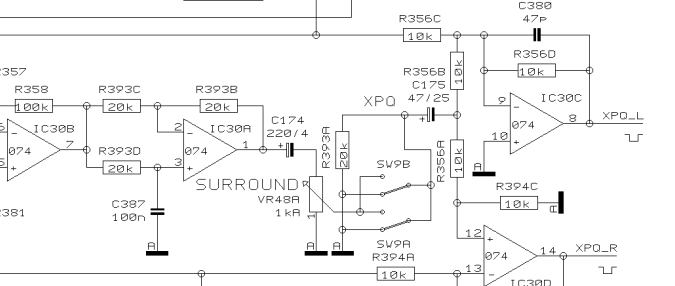
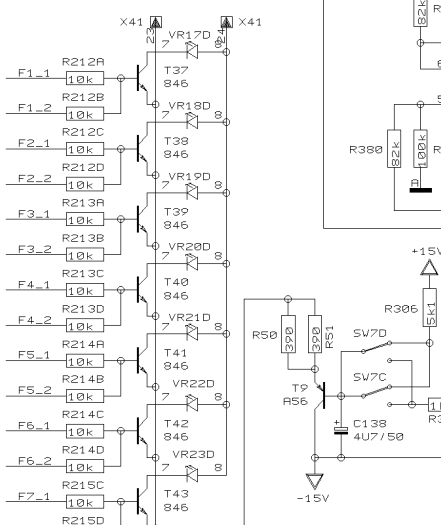
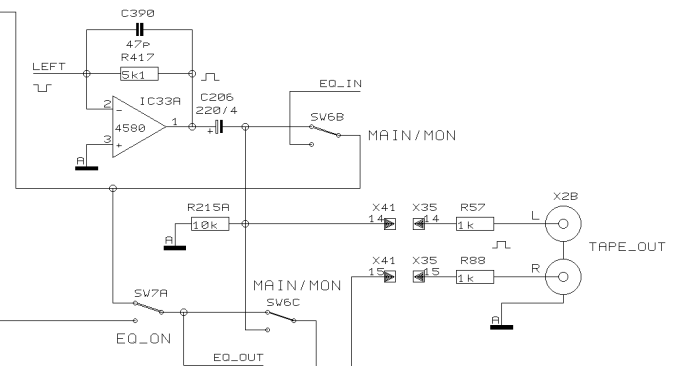
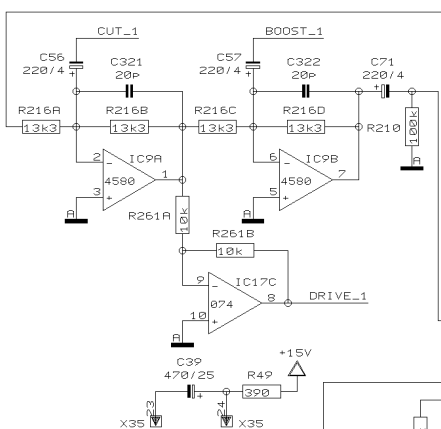
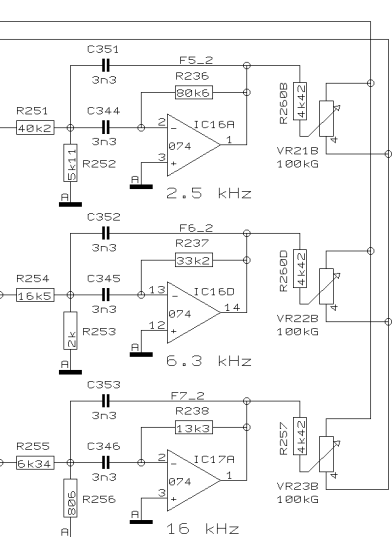
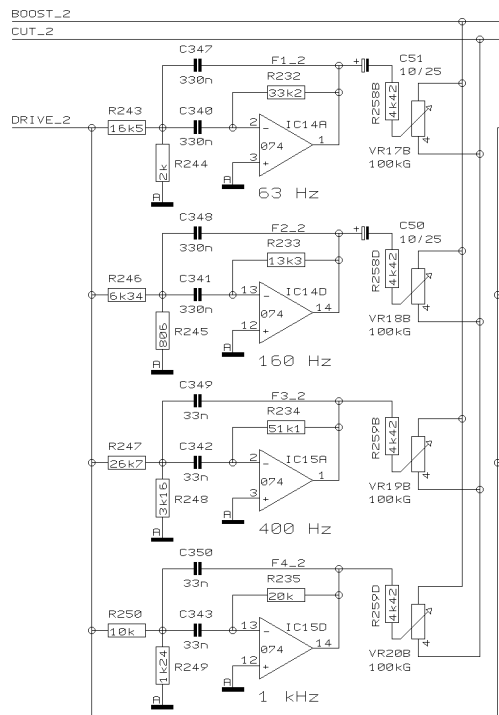
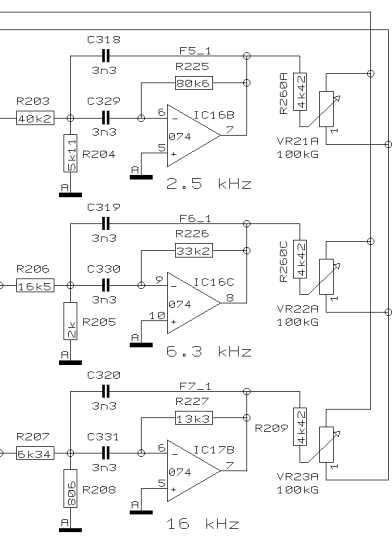
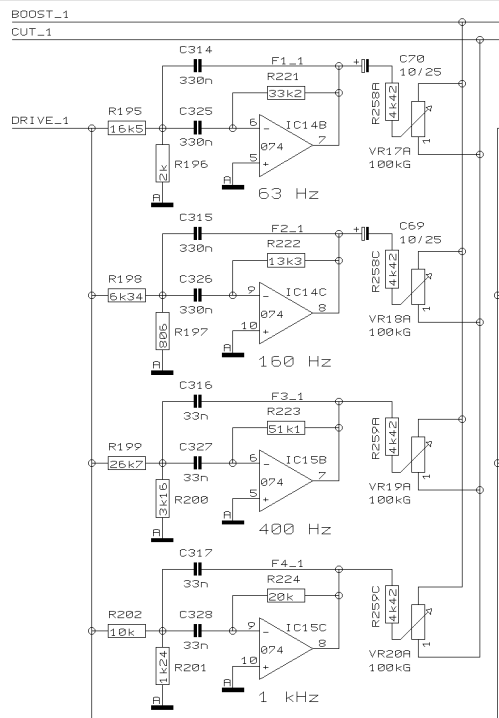

REVISIONS
A

DRAWN SA

CHECKED

DATE 14.02. 6
15:19



PROJECT
1222FX
XENYX 1222FX
GRAPHIC EQ / FBO / XPO
SHEET 6 OF 8 SHEETS TOTAL

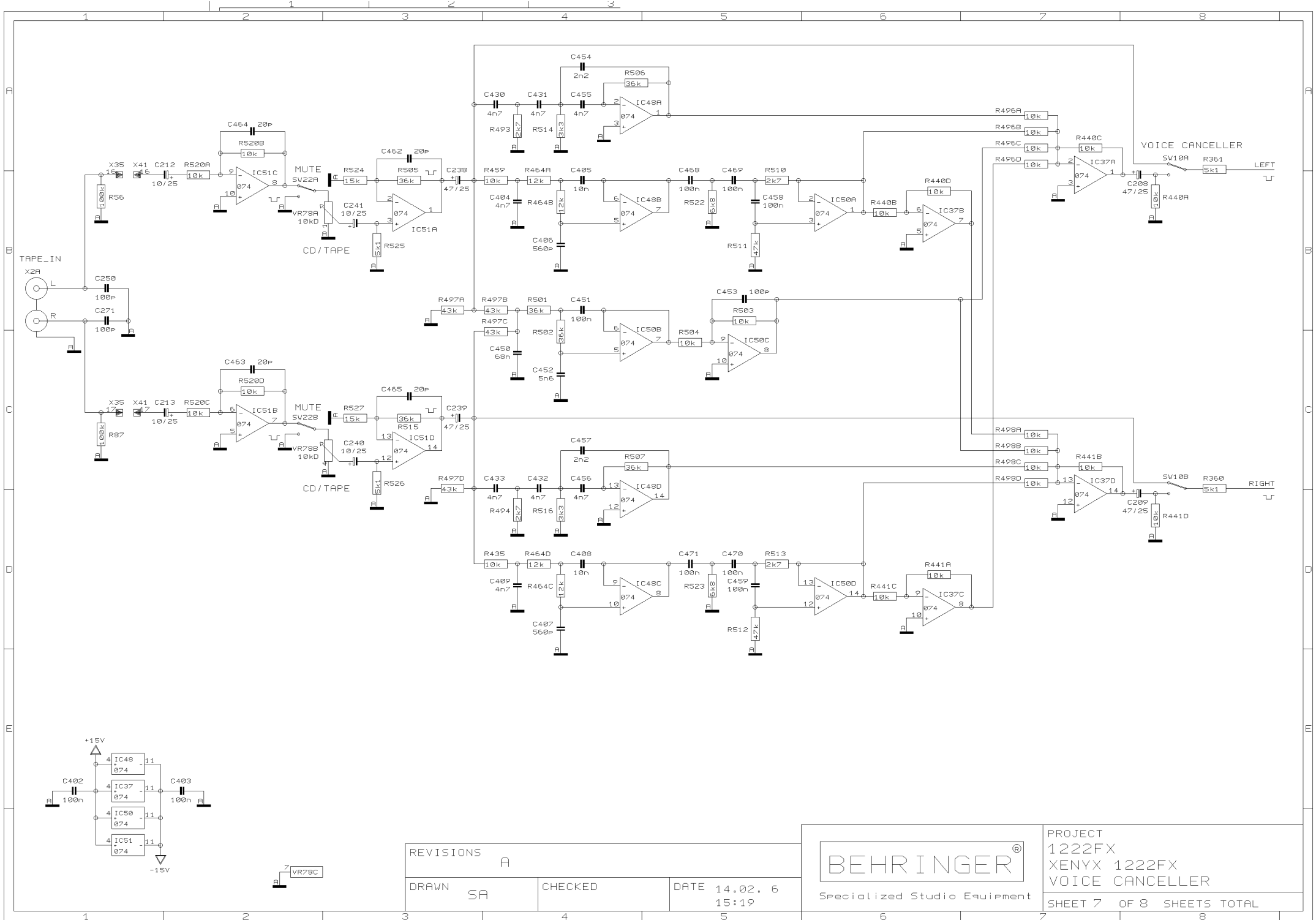

REVISIONS		
A		
DRAWN	CHECKED	DATE
SA		14.02. 6
		15:19



PROJECT
1222FX
XENYX 1222FX
VOICE CANCELLER
SHEET 7 OF 8 SHEETS TOTAL

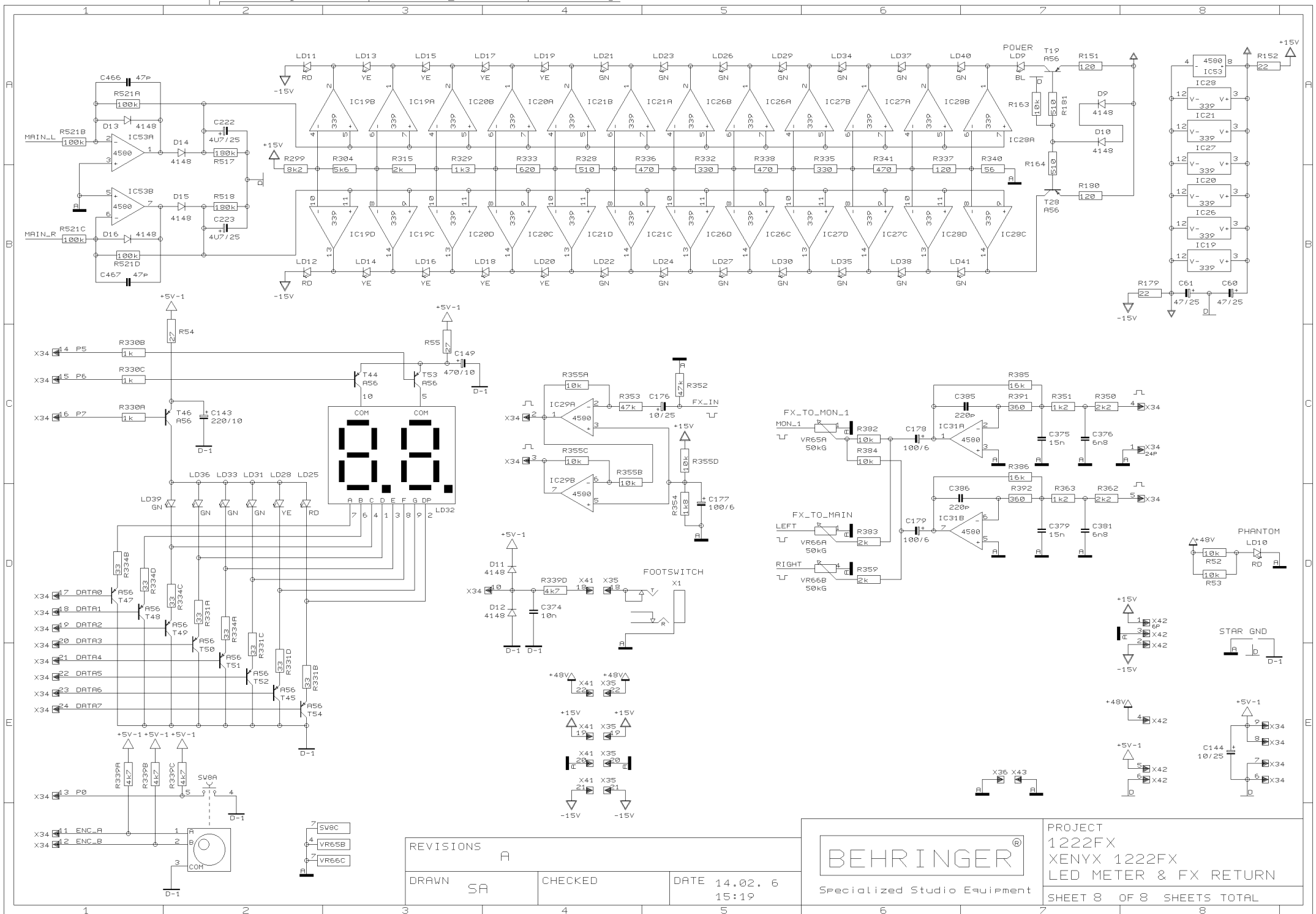

REVISIONS		
A		
DRAWN	CHECKED	DATE
SA		14.02. 6
		15:19



PROJECT
1222FX
XENYX 1222FX
LED METER & FX RETURN
SHEET 8 OF 8 SHEETS TOTAL

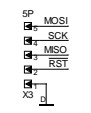
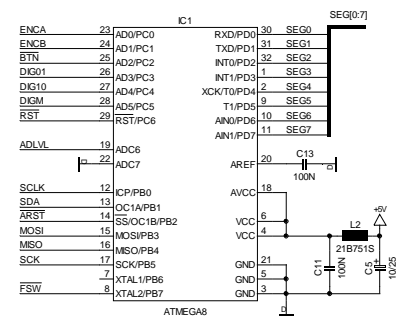
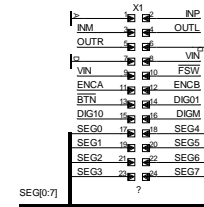
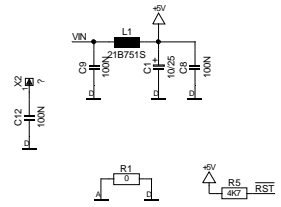
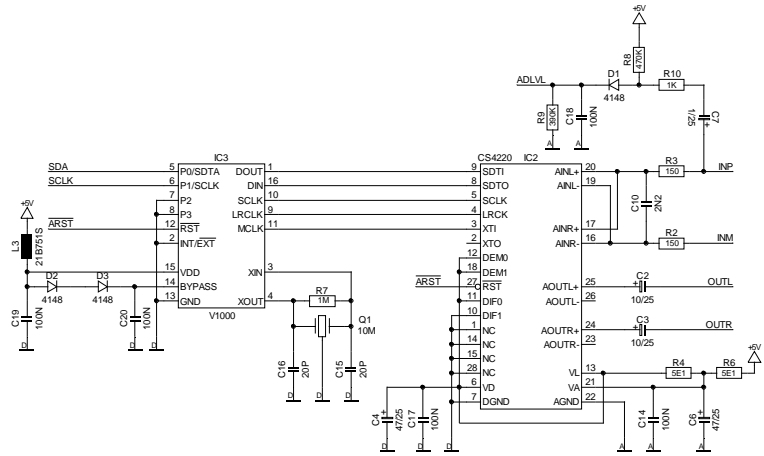

		DATE	NAME	V1000 BASED FX MODULE REPLACEMENT FOR DPM5M	
		DRWN	14.06.2005	TK	
		CHKD			
		APPR			
B	LIBRARY/REVISION	22.07.2005	TK		
A	ORIGD	14.06.2005	TK		
REV	CHANGES	DATE	INT	FILE:	DPM5V1000

ALL INFORMATION (INCLUDING DRAWINGS AND DIAGRAMS) CONTAINED IN THIS DOCUMENT IS THE PROPERTY OF BEHRINGER. ADDRESSEES WHOM THE INFORMATION IS CONFIDED TO SHALL MAINTAIN THE INFORMATION IN CONFIDENCE AND SHALL NOT RELEASE IT TO ANY UNAUTHORIZED THIRD PARTIES (EXCEPT UNDER ATTORNEY CLIENT PRIVILEGE OR UNDER APPROPRIATE CONFIDENTIALITY AGREEMENTS). ANY UNAUTHORIZED DISCLOSURE, USE, APPLICATION OR ANY OTHER DEALINGS IN THE INFORMATION SHALL RESULT IN CIVIL AND/OR (WHERE APPLICABLE) CRIMINAL LIABILITIES AND PENALTIES.

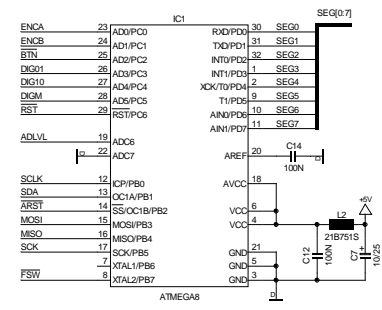
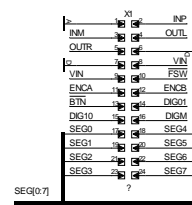
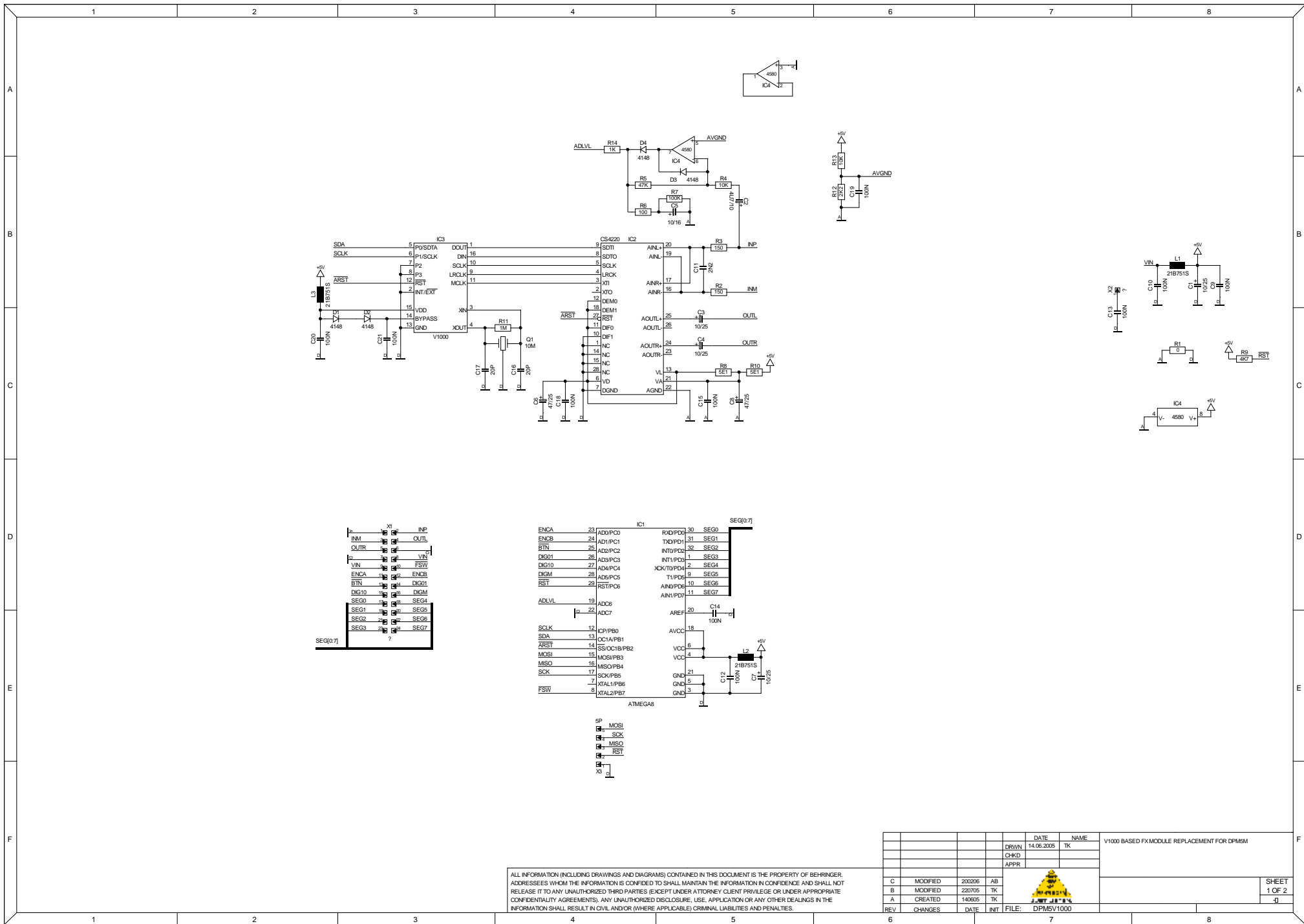

REV	CHANGES	DATE	INT	FILE	NAME	DATE	CHKD	APPR	DESCRIPTION
A	CREATED	14.06.2005	TK		V1000 BASED FX MODULE REPLACEMENT FOR DPMSM				
B	MODIFIED	22.07.05	TK						
C	MODIFIED	20.02.06	AB						

ALL INFORMATION (INCLUDING DRAWINGS AND DIAGRAMS) CONTAINED IN THIS DOCUMENT IS THE PROPERTY OF BEHINGER. ADDRESSEES WHOM THE INFORMATION IS CONFIDED TO SHALL MAINTAIN THE INFORMATION IN CONFIDENCE AND SHALL NOT RELEASE IT TO ANY UNAUTHORIZED THIRD PARTIES (EXCEPT UNDER ATTORNEY CLIENT PRIVILEGE OR UNDER APPROPRIATE CONFIDENTIALITY AGREEMENTS). ANY UNAUTHORIZED DISCLOSURE, USE, APPLICATION OR ANY OTHER DEALINGS IN THE INFORMATION SHALL RESULT IN CIVIL AND/OR (WHERE APPLICABLE) CRIMINAL LIABILITIES AND PENALTIES.

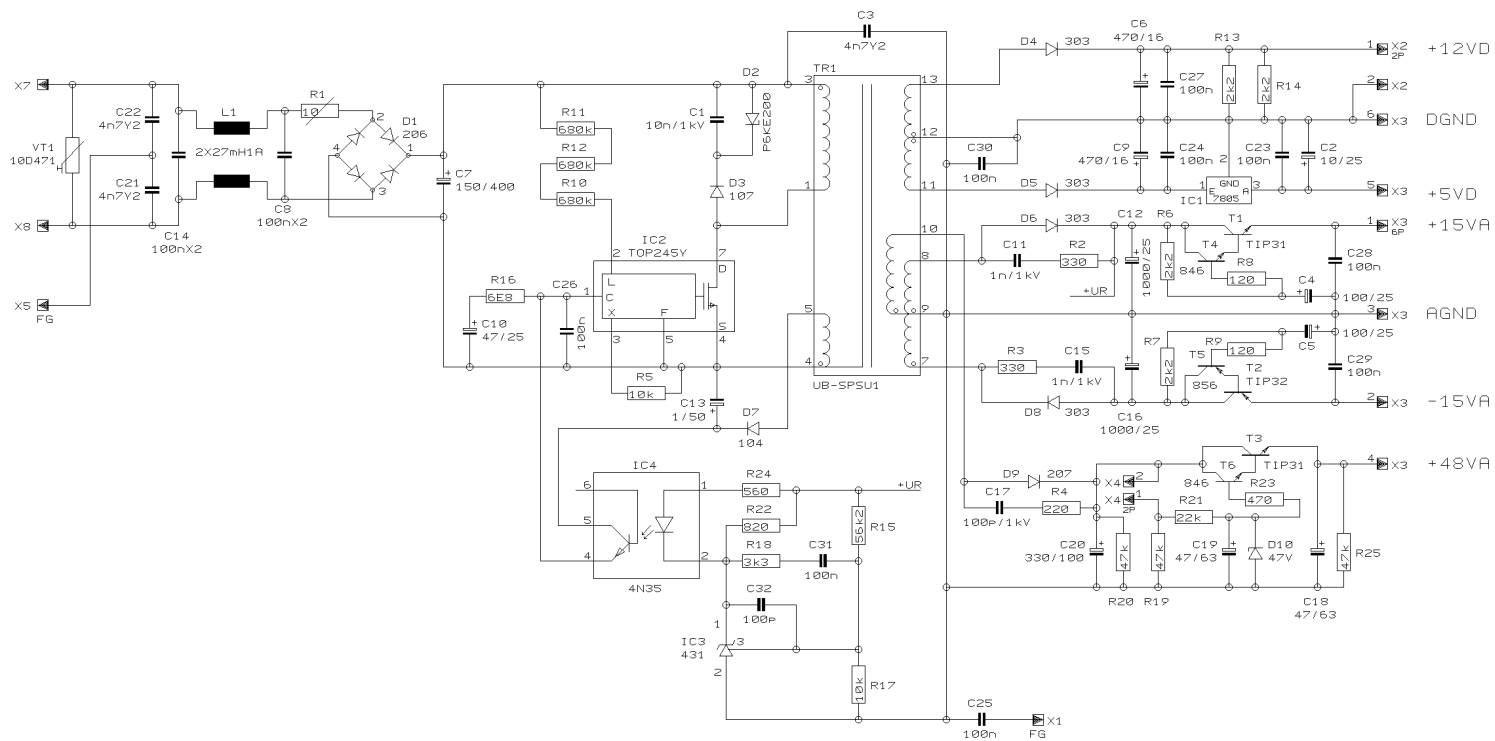

REVISIONS F (07/09/04)

DRAWN TZ

CHECKED

DATE 23.11. 6
14:27

BEHRINGER®

Specialized Studio Equipment

PROJECT
UB-SPSU2
SWITCH MODE PSU
FOR UB MIXER SERIES

SHEET 1 OF 1 SHEETS TOTAL